

--

Date:
Client:
Project:



5471S-061A

¾" thermostatic mixer.

5471S-061AUP = Thermostatic mixer 5400FV, 200M.

5471S-061AAP = Handle NR51, handle NR52, handle NR64G, hand shower and hand shower holder with non-return valve 070S, hose 1500 mm, ceiling-mounted head shower 060A, 60 mm circular flanges: 001, 001G, 3 pcs 2001.

Flow

	Bar:	1.0	2.0	3.0	4.0	5.0
060A ¹⁾	(l/min)	12.7	18.0	22.0	25.4	28.4
070S ²⁾	(l/min)	6.9	9.8	12.0	13.9	15.5

¹⁾ USA: Flow restricted to 1.8 gpm (7.0 l/min)

²⁾ USA: Flow restricted to 2 gpm (7.6 l/min)

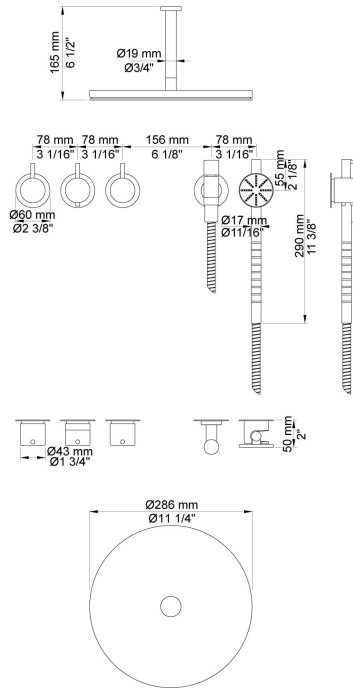

Available in colors

Color 02, Grey	Color 21, Carmine red
Color 04, Light blue	Color 25, Pink
Color 05, Orange	Color 27, Matt black
Color 06, Light green	Color 28, Matt white
Color 08, Yellow	Color 40, Brushed stainless steel
Color 09, Dark grey	Color 60, Black
Color 12, Mocca	Color 61, Brushed black
Color 14, Bright red	Color 62, Deep black
Color 15, Dark blue	Color 63, Copper
Color 16, Polished chrome	Color 64, Brushed Copper
Color 17, Gloss black	Color 65, Gold
Color 18, White	Color 68, Silver
Color 19, Natural brass	Color 70, Brushed Gold
Color 20, Brushed chrome	

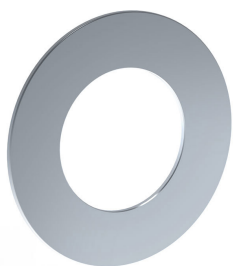

001
60 mm circular flange.
Hole Ø30 mm.

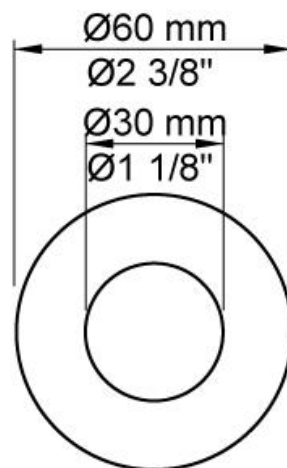

001G
60 mm circular flange. Hole Ø33 mm.

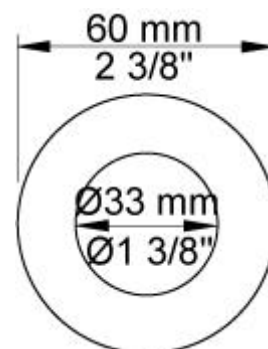

060A
Head shower, round, ceiling-mounted.
60 mm cover flange included.

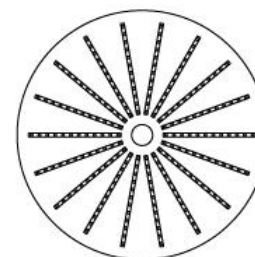
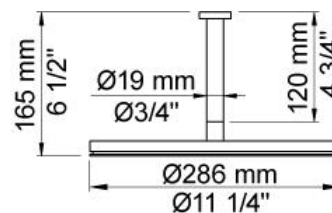



070S
Hand shower, hand shower holder and hose with non-return valve.

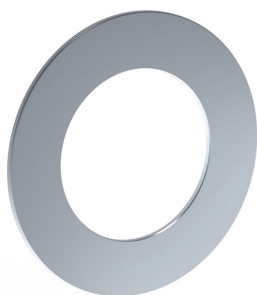
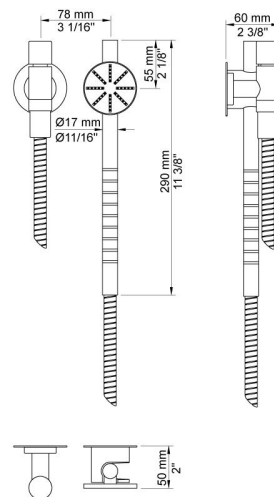

2001
60 mm circular flange.
Hole Ø39 mm.

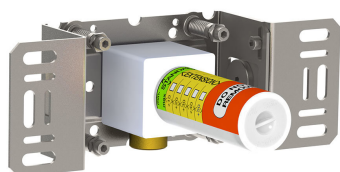
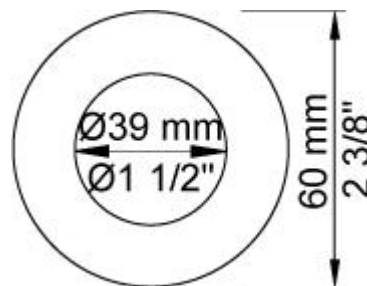

200M
Separate outlet socket.
½" connection to copper, steel, iron or pex pipe work.

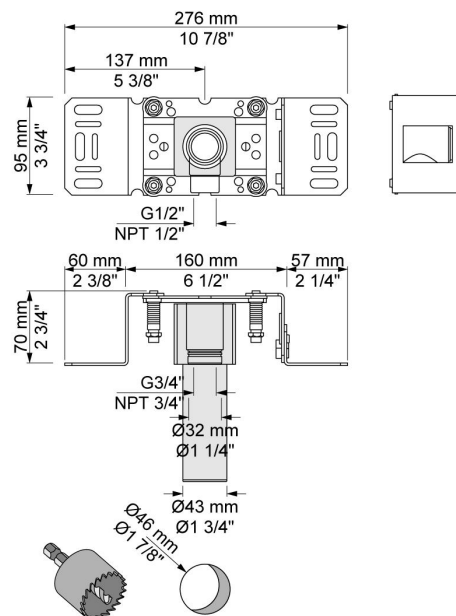

**NR64G**

Diverter handle for 5400/5600.

With peg in the same colour as handle (Standard).

